

shindaiwa®

OPERATOR'S MANUAL

SP401BP 4 Gallon Backpack Manual Sprayer

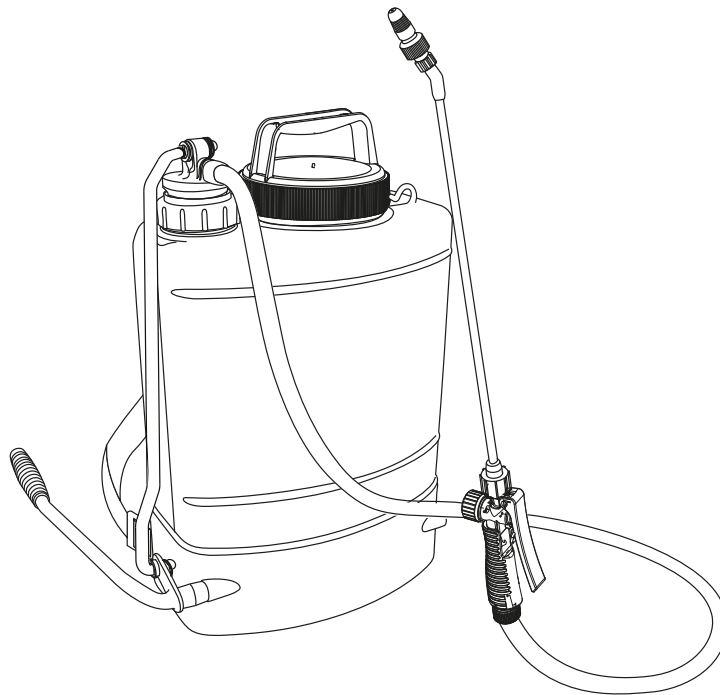

SERIAL NUMBER

507MS0000001 - 507MS9999999

! WARNING

Cancer and Reproductive Harm
www.P65Warnings.ca.gov



*Read and understand all provided literature before use.
Failure to do so could result in seriously injury.*

INDEX

1. Introduction.....	3	4. Operation.....	9
2. Safety information.....	4, 5	5. Maintenance.....	9
2.1 Personal protective equipment		5.1 Maintenance guide	
2.2 Safety Instructions		6. Troubleshooting guide.....	10
3. General Information.....	7	7. Product Registration.....	11,12
3.1 Main components		8. Warranty.....	13
3.2 Technical data			
3.3 Chemical compatibility			
3.4 Assembly			
3.4.1 Parts you will receive			
3.4.2 How to assemble your sprayer			

1. INTRODUCTION

Specifications, descriptions and illustrative material in this literature are as accurate as known at the time of publication, but are subject to change without notice. Illustrations may include optional equipment and accessories, and may not include all standard equipment.



Read and understand all provided literature. Literature contains specifications and information for safety, operation, maintenance, storage, and assembly specific to this product. Scan QR codes for more information.



For additional literature, including safety manuals where applicable, or questions regarding items used in this manual, visit:

<https://www.echo-usa.com/manuals>

OR



<https://www.shindaiwa-usa.com/manuals>



This manual contains important safety warnings, please read it carefully to avoid any possible accident. Keep all warning stickers and if necessary replace them.

Servicing Information

Parts / Serial Number

Genuine Shindaiwa Parts and Assemblies for your Shindaiwa products are available only from an Authorized Shindaiwa Dealer. When you do need to buy parts always have the Model Number and Serial Number of the unit with you. For future reference write them in the space provided below

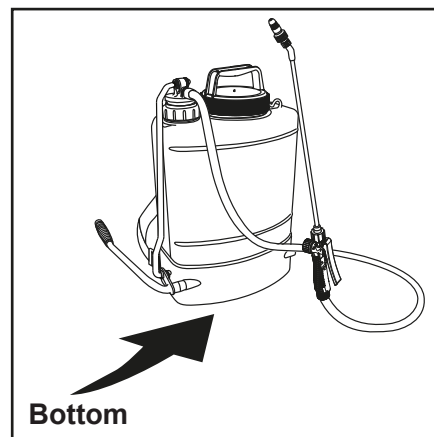

Model No. _____

Serial No. _____

2. SAFETY INFORMATION

Manual Safety Symbols and Important Information

Throughout this manual and the product itself, you will find safety alerts and helpful, informational messages preceded by symbols or key words.

The following and explanation of those symbols and key words and what they mean to you.











WARNING

The safety alert symbol accompanied by the word “WARNING” calls attention to an act or condition which CAN lead to serious personal injury or death if not avoided.



CIRCLE AND SLASH SYMBOL

This symbol means the specific action shown is prohibited. Ignoring these prohibitions can result in serious or fatal injury.

Symbol	Description	Symbol	Description
	Wear Hand Protection		No Flammable Liquids
	Wear Safety Mask		Corrosive
	Wear Safety Glasses		Corrosive
	Wear Safety Coveralls	 30°C / 86°F	Temperature Limit
	Wash your hands before to operate Sprayer		Toxic substances
	Clean Sprayer		

2.1 PROTECTION EQUIPMENT

- Industrial gloves
- Safety glasses
- Closed toe footwear
- Coverall
- Safety mask

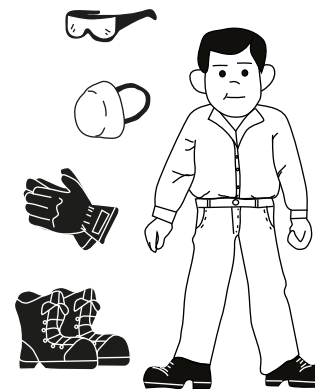

- Read this manual carefully before operating the equipment.
- Incorrect handling by unqualified persons may cause serious accidents.
- Do not make modifications or adaptations because they can compromise your equipment and put your safety and that of a third party at risk. They also invalidate the warranty.
- Do not allow the presence of children, the elderly, people with disabilities or animals when using the equipment.
- Keep your equipment in good condition and in a safe place. Always wash and store your equipment without pressure.
- Read and follow the instructions of the chemical product you are going to apply.
- Wear the personal protective equipment mentioned above when using, filling or washing your sprayer.
- Keep connections tight to prevent leaks.
- Never fill your sprayer with hot liquids, maximum: 30 ° C = 86 ° F.

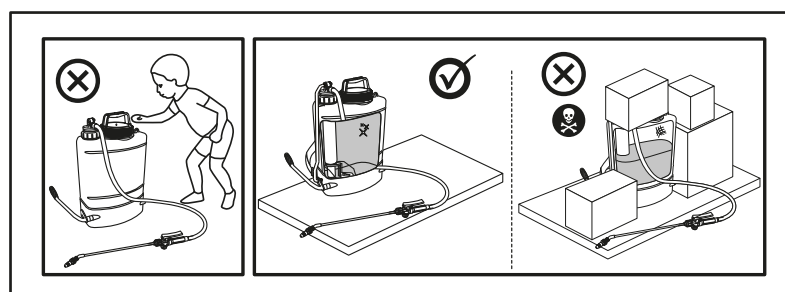
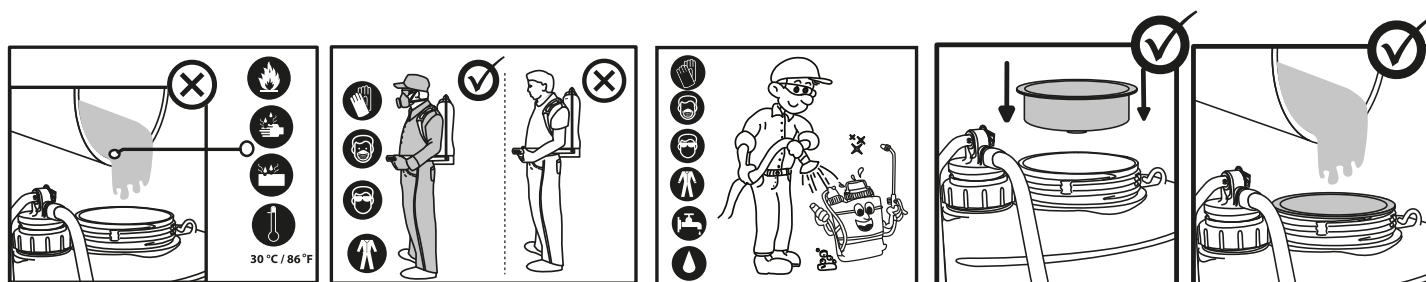

SAFETY INSTRUCTIONS

WARNING DANGER

Carrefully read and understand the Operator's Manual supplied with this unit prior to filling, using and/or cleaning this sprayer. DO NOT use flammable liquids in the sprayer. They can ignite and explode. Always wear splash goggles and all required protective gear and clothing when filling, using, cleaning, or performing maintenance on the sprayer failure to follow all instructions can result in fire, explosion, and serious injury.

- Always inspect your sprayer thoroughly before and after each use. Check to be sure hose is securely attached and in good condition before pressurizing the tank.
- Do not spray on or near electrical installations.
- Keep the work area clear of people and animals.
- Do not use sprayer when wind conditions cause spray to contact operator, plants, or other surfaces that may be harmed by spray solutions.
- Wear a mask or respirator when filling, using, and cleaning sprayer, if recommended by the spray material manufacturer.
- A backpack sprayer is a tool for spraying chemicals, and because of this, special safety precautions must be observed to reduce the risk of personal injury. Do not use it for other purposes since misuse may result in personal injury or damage, including the sprayer itself.
- Your judgment and physical abilities may not be good if you are tired or sick, are taking medication, and have taken alcohol or drugs. Operate the sprayer only if you are physically and mentally well.
- Working with any backpack sprayer can be strenuous, if you get tired, take a break. Tiredness may result in loss of concentration and control.
- Adjust shoulder harness for comfortable operation before starting work. To reduce the risk of spillage, keep container upright, do not bend at the waist always bend at the knees and support yourself to ensure proper balance. Remember that a sprayer filled with liquid has a significant amount of weight. Use caution when bending, leaning, or walking.
- Maintain footing and balance at all times. Do not stand on slippery, uneven or unstable surfaces. Do not work in odd positions or on ladders.
- Do not operate your backpack sprayer indoors or in inadequately ventilated areas. Operate the sprayer under good visibility and daylight conditions only. Avoid spraying towards people, pets, open windows, or vehicles.
- Oil the pump tube tank seal o-ring prior to first usage so the o-ring will seal properly.
- Tighten all conections before using the sprayer. Conections may have loosened during shipping and handling.
- Always release pressure in the tank prior to first usage so the o-ring will seal properly.
- Before opening a container of pesticide or other spray material, carefully read, understand, and follow all instructions on the label.
- Never use caustic or corrosive chemicals wich could damage the unit.
- Do not use hot liquids in sprayer. Maximum temperature 30°C, 86°F

- Do not drop a tank that has been pressurized. If tank is dropped, inspect immediately. Consult chemical manufacturer's instructions for other important safety information.
- Never attempt to pressurize the unit by any other method than with the pump module provided. Never over-pressurize the unit.
- Do not eat, drink, or smoke while spraying.
- Wash face and hands with soap and water after spraying.
- Clean and rinse tank and spray gun/wand assembly after each use to prevent crystallizing, and clogging or chemical damage to the unit.
- Do not store sprayer under pressure, or with spray solution in tank.
- Do not transfer spray material to other containers, especially food and/or drink containers.
- Keep spray material locked up and out of reach of children and animals.
- Use only original manufacturer's replacement parts.

3. GENERAL INFORMATION

3.1 MAIN COMPONENTS

1. Tank
2. Tank opening, tank lid
3. Strainer
4. Pump tube with piston sleeve
5. Pump lever
6. Ergonomic grip
7. Pump handle
8. Shut-off valve with filter
9. Adjustable plastic nozzle
10. Hose
11. Adjustable carrying straps
12. Guide nut
13. Spray lance

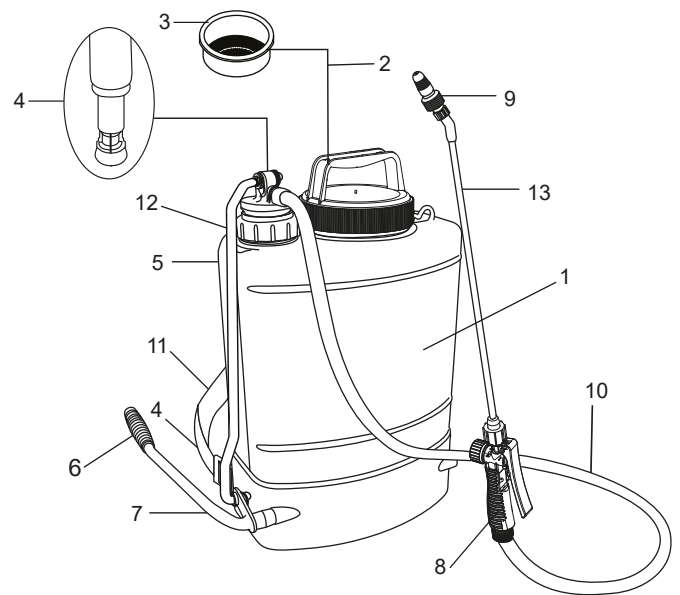

3.2 TECHNICAL DATA

SPECIFICATIONS	
Model	SP401BP
Tank capacity	15.0 L / 4.0 US gal
Filling port	14.2cm / 5.6"
Carrying Straps	Padded with belt
Pumping system	Plastic Piston
Piston Sleeve	1.8"/45 mm
Hose	Fiber vinyl reinforced 1/4" ID
Shut-Off valve	Professional with filter
Spray wand	20"/52 cm fiber glass
Nozzle	Plastic adjustable
Discharge at 3 bar/min	0.21 US gal / 800 ml
Work pressure	1 - 6 bar / 14.5 - 87 psi
Net Weight	5.3 kg / 11.6 Lbs
Weight with box	5.9 kg / 13 Lbs
Dimensions	22X14.7 X 8.6" / 51.5 X 39 X 22 cms

3.3 CHEMICAL COMPATIBILITY

CHEMICAL/SOLVENT	SP401BP
Acetone	No
Asphalt	No
Benzene	No
Bleach Solution up to 15%	Yes
Boric Acid	Yes
Denatured Alcohol	No
Diesel Fuel	No
Enamel Paint	No
Ethyl Alcohol	No
Hydrochloric Acid	Yes
Isopropyl Alcohol	No
Kerosene	No

CHEMICAL/SOLVENT	SP401BP
Lacquer Solvents	No
Latex Paint	No
Methyl ethyl ketone	No
Naptha	No
Ridomill	Yes
Round Up	Yes
Sulfuric Acid	No
Toluene	No
Wettable Powders	Yes
Xylene	No
Note: max 5% allowed	

3.4 ASSEMBLY

3.4.1 Parts you will receive

- 1 Pump handle
- 1 Pump lever
- 1 Spray wand
- 1 Tank lid
- 1 Operator's manual

Inside the tank you will find:

- 1 Strainer
- 1 Bushing guide
- 1 Felt ring
- 1 Pump tube with hose and shut-off valve
- 1 Agitator

And a plastic bag with:

- 1 washer
- 1 "R" lock pin
- 3 washers and 3 "c" lock pin
- 1 Adjustable nozzle

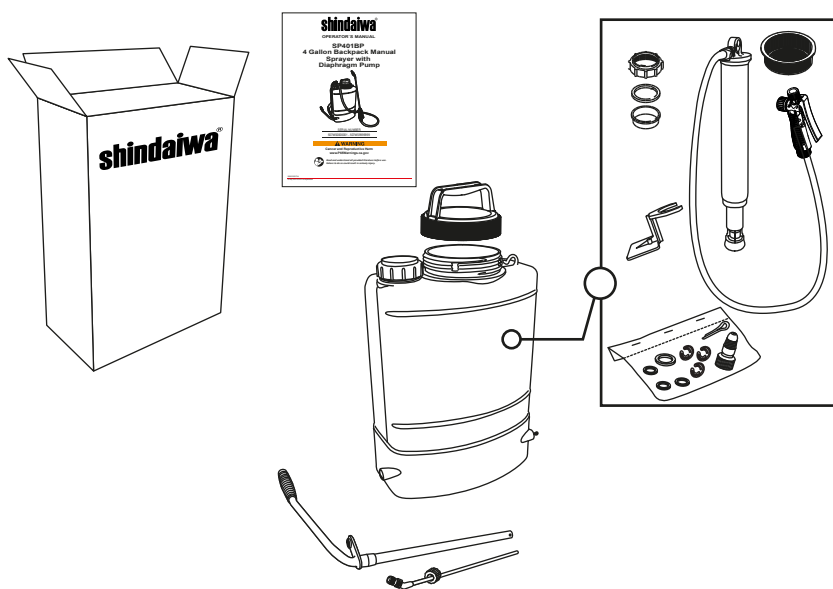

3.4.2 How to assemble your sprayer:

Following is an explanation of how to assemble your sprayer, carefully read the instructions. The number at the beginning of the line corresponds to the graphic.

1. Take out all the parts from the box and from the tank.
2. Place the sprayer vertically on a table, place the pump holder nut, gasket and felt ring on the side opening. Oil the piston sleeve and the pump tube, insert it in the pump tube guide; carefully directing the piston sleeve to avoid any damage.
3. Tighten the pump holder nut. Place the agitator.
4. Place the strainer and the tank lid on the tank opening.
5. Insert the connecting rod in the pump tube placing one flat washer on each side, secure them with the lock pins "C".
6. Pass the pump handle through the base of the tank attaching it to the connecting rod with a flat washer and a lock pin "C" and on the other end with a lock washer and a cotter pin.
7. Finally tighten the spray gun and tube.

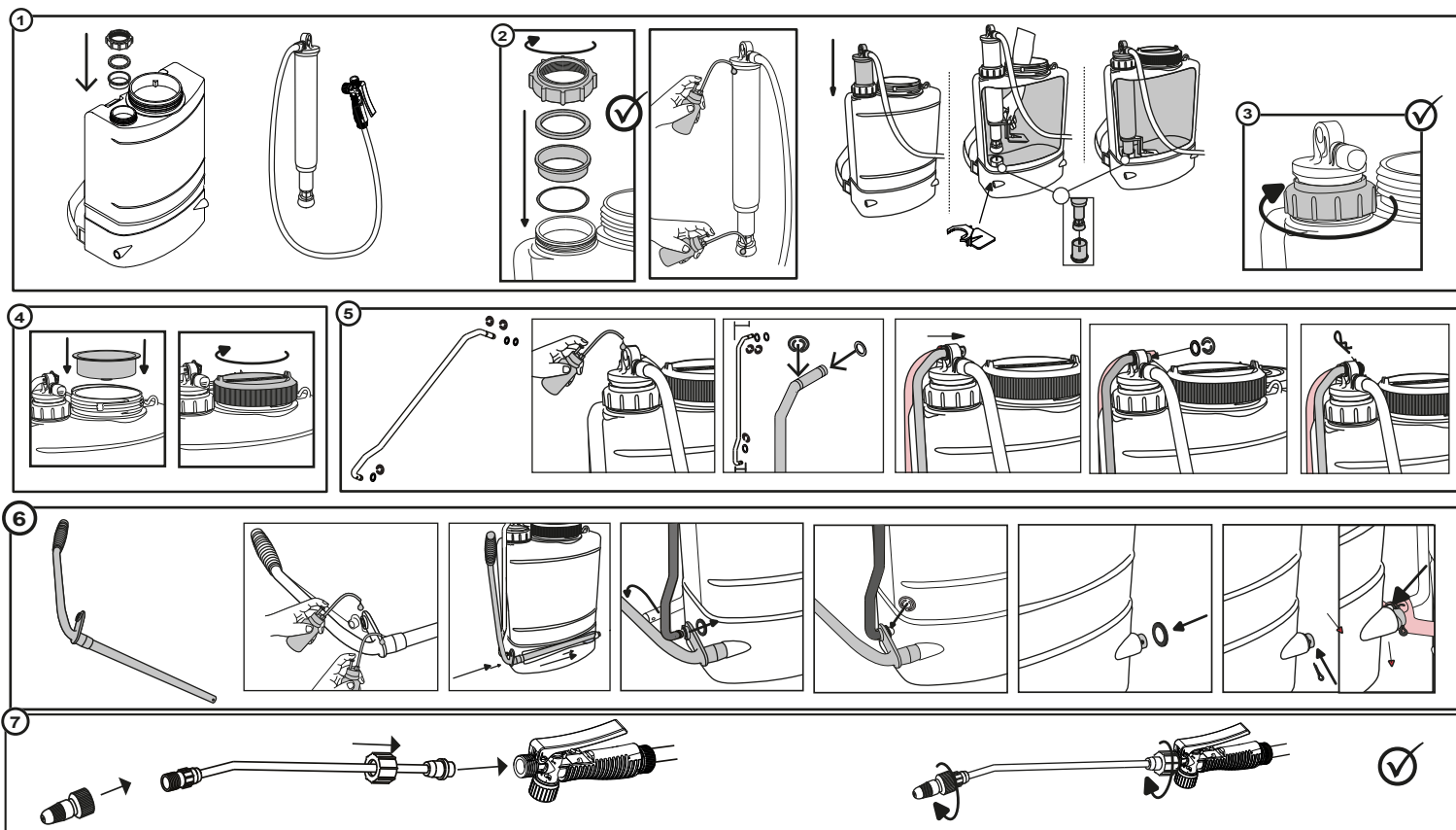

4. OPERATION

- Always use the strainer when filling the tank up with liquid.
- Mix the solution in a separate container, following the supplier directions on the box.
- Pour pre-mixed solution into sprayer and cap.
- Place the sprayer on your back and pressurize tank by pumping approximately 25 times.
- You will need to pump once each 3 or 4 seconds to maintain the desired spraying pressure.
- For a continuous spraying, adjust the shut-off valve lever with the lever lock.
- Move the nozzle cap to change the spraying pattern.

NOTE:

To ensure good performance use original "SHINDAIWA" replacement parts

5. MAINTENANCE

Since the sprayer needs little maintenance, if you follow the steps mentioned in this manual its lifespan will be very long. Do not keep the sprayer with pressure after finishing your spraying job, release the pressure through the nozzle by depressing the trigger, into a suitable container to re-use later or to dispose of properly.

- Pour approximately 1/2 gallon of fresh water in the tank, pressurize and flush, the pumping system by pressing trigger at least 2 minutes, then drain all remaining water.
- Carrying straps are made of non-absorbent materials, nevertheless in case of solution spillage, wash them with fresh water to eliminate all risk of skin irritation.
- A unit that has been used with herbicides should never be used to spray insecticides, unless the sprayer has been properly cleaned and all other chemicals neutralized. Failure to do this could cause you to kill plants that have been sprayed.
- Always follow manufacturer's instructions of the chemicals in use to avoid accidents and take maximum advantage of the product. Store your sprayer clean, empty and dry in a place protected from sunlight.

NOTE: To keep your sprayer in good condition it is necessary to oil the following parts:

Nozzle O-rings, gun o-rings, piston ring, gasket, breather valve and cap gasket.

5.1 MAINTENANCE GUIDE

Below are instructions for maintaining your sprayer:

Rinse with clean water externally and internally, to avoid risk of contamination. To keep your sprayer in good condition it is recommended to change the following parts when servicing your sprayer:

- O-rings, - Piston Ring, - Gun o-rings, - O-rings for nozzle, - Gasket, - Breather valve,

Disassembly instructions:

1. Place the sprayer on a flat surface. Pull the pin from the upper end out of the pump lever.
2. Loosen the pump holder nut and take the lever out.
3. Pull out pump tube and check the plastic ball and the piston inside the tube, remove piston and make sure the ball and piston is clean and in good shape, if not replace it.
4. Once you replace it, repeat this steps backwards. Do not forget to lubricate it.

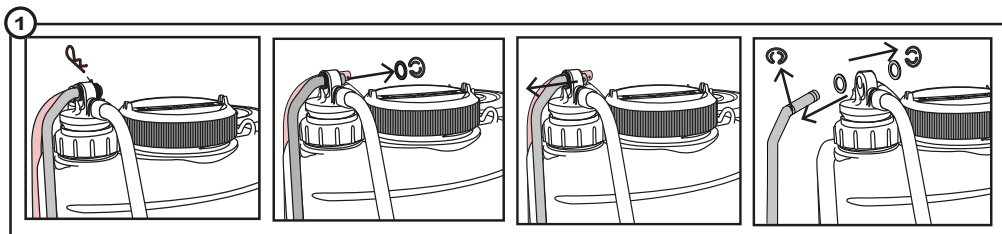

NOTE:
To lubricate all parts, use multipurpose grease.

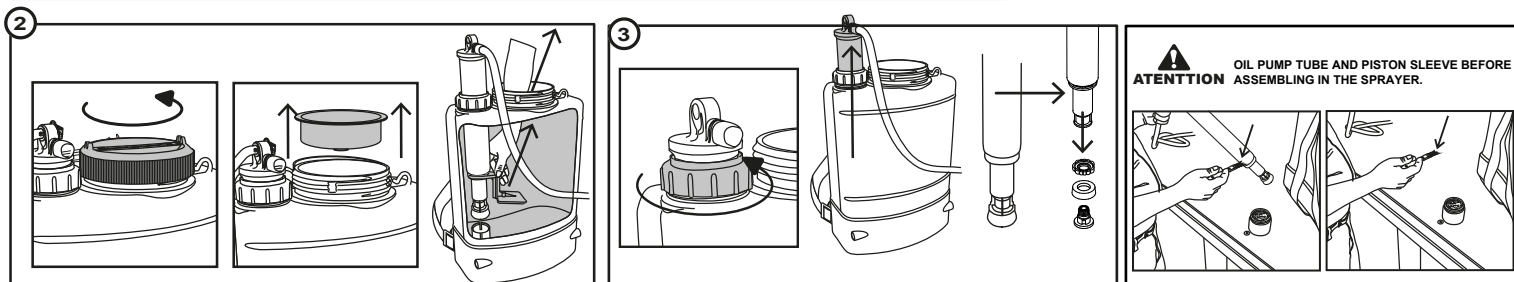

6. TROUBLESHOOTING GUIDE

PROBLEM	CAUSE	SOLUTION
The tank collapses when pressurizing it.	The breather check valve needs lubrication.	Lubricate the breather check valve or replace the complete lid.
The piston sleeve does not run smoothly and it is hard to pump.	The chemical used has made the piston sleeve swell up.	Lubricate the piston sleeve or replace it.
The piston sleeve runs too smoothly and it does not keep pressure.	The piston sleeve is worn out or shrunk.	Lubricate the piston sleeve or replace it.
Although the sprayer is being pumped vigorously it does not build pressure.	The plastic ball is stuck or dirt is preventing the ball from sitting properly on the ball-holder nut.	Clean the ball holder nut and the ball.
When pumping a creak is produced between the pump tube and pump holder nut.	The pump tube and pump holder nut need lubrication.	Lubricate both of them.
The shut-off valve does not close after releasing the trigger.	The plunger O-rings are worn out or swollen.	Replace them and lubricate the plunger.
The shut-off valve does not function when depressing the trigger.	The filter or nozzle are blocked.	Take the filter out of the shut-off valve and clean or replace it. Clean the nozzle.

PRODUCT REGISTRATION

Thank you for choosing Shindaiwa Sprayer Equipment

Please go to <http://www.shindaiwa-usa.com> to register your new product on-line. It's FAST and EASY! NOTE: your information will never be sold or misused by ECHO, Incorporated.

Registering your purchase enables us to contact you in the unlikely event of a service update or product recall, and verifies your ownership for warranty consideration.

If you do not have access to the internet, you can complete the form below and mail to:

***ECHO Incorporated, Product Registration, PO Box 1139,
Lake Zurich, IL 60047.***



PRODUCT REGISTRATION CARD : TARJETA DE REGISTRO : CARTE D'ENREGISTREMENT DU PRODUIT

ONLINE OPTION: Register online and save a stamp! You will be alerted of product updates and/or be sent new ECHO product information and special offers. Simply go to: www.echo-usa.com

OPCIÓN POR INTERNET: Regístrese en la página web y ahorre una estampilla! Le alertaran sobre actualizaciones del producto y/o se le enviara información sobre los nuevos productos ECHO y las ofertas especiales. Simplemente visite: www.echo-usa.com

OPTION EN LIGNE : Enregistrer en ligne et épargner un timbre! Vous serez informé sur les nouveaux produits ECHO et les mises à jour de produit ainsi que les offres spéciales. Simplement visitez le: www.echo-usa.com

Please Print : Por Favor Escriba Con Letra De Molde : En Lettre Carré S.V.P.

Confidential: Information provided will not be shared or sold

Purchaser's Name : Nombre del Comprador : Nom de l'acheteur

Primary use of tool: Professional Homeowner Rental Equip.
 Uso primario de la herramienta: Profesional Dueño de casa Alquiler
 Usage principal : Professionnel Residential Location

Address : Dirección : Adresse

Do you wish to receive periodic ECHO product information and special offers by e-mail? Yes No
 ¿Desea usted recibir información periódica y ofertas especiales por correo electrónico sobre el producto ECHO? Yes No

City : Ciudad : Ville

State : Estado : Province

Zip Code : Código Postal : Code Postal

Souhaitez-vous recevoir périodiquement de l'information sur les produits ECHO et les offres spéciales par courrier électronique ? Oui Non

E-Mail Address : Dirección De Correo Electrónico : Courrier Électronique

Did you visit the ECHO website before purchasing your product?
 Yes No

Visitó usted la pagina web ECHO antes de comprar su producto?

Si No

Avez-vous visité le site d'ECHO avant de procurer votre produit?

Oui Non

Phone Number : Número De Teléfono : Téléphone

Date of Purchase : Fecha de la Compra :
 Date de l'achat

What factor(s) most influenced your purchase?

Performance Price Dealer
 Reliability Prior Experience Quality
 Friend/Family Brand Warranty

Where Purchased : Nombre del Almacén donde fue Comprado : Lieu d'achat

¿Qué factor(es) influyó más en su compra?
 Funcionamiento Precio Distribuidor
 Confiabilidad Experiencia Anterior Calidad
 Amigo/Familia Marca Garantía

Model Number : Numero del Modelo : No. de modéle

Serial Number : Numero de Serie : No. de série

Quel facteur (facteurs) vous a influencé le plus?
 Performance Prix Marchand
 Fiabilité Expérience Qualité
 Ami/Famille Marque Garantie

Registering your purchase enables us to contact you in the unlikely event of a service update or product recall and verifies your ownership in the event of loss. : El registrar su compra nos permite estar en contacto con usted en caso de cualquier evento como el aviso de tiempo de servicio o la revocación del producto y verificación de propiedad en caso de robo o pérdida. : L'enregistrement de votre achat nous permettra de vous contacter dans le cas improbable de modifications des instructions d'entretien ou de rappel du produit et vérifier que vous êtes le propriétaire en cas de vol ou de perte.

ECHO INC., 400 Oakwood Rd., Lake Zurich, IL 60047
 1.800.432.ECHO WWW.ECHO-USA.COM

X7572270206 02-2012

**ECHO INCORPORATED LIMITED WARRANTY STATEMENT FOR
ECHO AND SHINDAIWA PRODUCTS SOLD IN USA AND CANADA BEGINNING 01/01/2010**

ECHO INCORPORATED'S RESPONSIBILITY

ECHO Incorporated's Limited Warranty, provides to the original purchaser that this ECHO or Shindaiwa product is free from defects in material and workmanship. Under normal use and maintenance from date of purchase, ECHO Incorporated agrees to repair or replace at ECHO Incorporated's discretion, any defective product free of charge at any authorized ECHO or Shindaiwa servicing dealer (as applicable) within listed below application time periods, limitations and exclusions. **THIS LIMITED WARRANTY IS ONLY APPLICABLE TO ECHO AND SHINDAIWA PRODUCTS SOLD BY AUTHORIZED DEALERS. IT IS EXTENDED TO THE ORIGINAL PURCHASER ONLY, AND IS NOT TRANSFERABLE TO SUBSEQUENT OWNERS EXCEPT FOR EMISSION RELATED PARTS.** Repair parts and accessories replaced under this warranty are warranted only for the balance of the original unit or accessory warranty period. Any damage caused by improper installation or improper maintenance is not covered by this warranty. All parts or products replaced under warranty become the property of ECHO Incorporated. This warranty is separate from and does not exclude or change the Emission Control Warranty Statement that is supplied separately with your new product. Please consult the Emission Control Warranty Statement for details regarding emission related parts. For a list of Authorized ECHO Dealers refer to www.echo-usa.com or call **1-800-432-ECHO**. For a list of Authorized Shindaiwa Dealers refer to www.shindaiwa-usa.com or call **1-877-986-7783**.

OWNER'S RESPONSIBILITY

To ensure trouble free warranty coverage it is important that you register your ECHO or Shindaiwa equipment on-line at www.echo-usa.com or www.shindaiwa-usa.com, or by filling out the warranty registration card supplied with your unit. Registering your product confirms your warranty coverage and provides a direct link if we find it necessary to contact you.

The owner shall demonstrate reasonable care and use, and follow preventative maintenance, storage, fuel and oil usage as prescribed in the operator's manual. Should a product difficulty occur, you must, at your expense, deliver or ship your ECHO or Shindaiwa unit to an authorized servicing dealer for warranty repairs (within the applicable warranty period), and arrange for pick-up or return of your unit after the repairs have been made. For your nearest authorized ECHO servicing dealer, visit www.echo-usa.com or call 1-800-432-ECHO (3246). For your nearest authorized Shindaiwa servicing dealer, visit www.shindaiwa-usa.com or call 1-877-986-7783. Should you require assistance or have questions concerning this Warranty Statement, you can contact our Consumer Product Support Department at 1-800-432-ECHO (3246). Contact us through the web at www.echo-usa.com, www.shindaiwa-usa.com, or Email us at support@echo-usa.com.

PRODUCT WARRANTY PERIOD

HOMEOWNER APPLICATION

- **5 YEAR WARRANTY** - All units for homeowner, or non-income producing use will be covered by this limited warranty for **five (5) years** from date of purchase.

EXCEPTIONS:

- All Cut-off saws and Cut-off Saw Carts for homeowner use will be covered by this limited warranty for one (1) year from the date of purchase.
- For two-stroke engine powered products, the electronic ignition module, flexible drive cables, trimmer solid drive shafts, and TC tines are warranted for the **life*** of the product on parts only.
- Cutting attachments such as, but not limited to, bars, chains, sprockets, blades, tines, belts, PowerBroom[™] and nylon trimmer heads for homeowner or non-income producing use will be covered for failures due to defects in material or workmanship for a period of **60 days** from original product purchase date. Any misuse from contact with concrete, rocks, or other structures is not covered by this warranty.
- Rapid Loader String Head carries a lifetime warranty on the line locking system, parts only; no labor. Refer to your operator's manual for string head installation and maintenance instructions.
- All SB-Series, Multipurpose Tool attachments, and PRO ATTACHMENT SERIES Split Shaft attachments carry the same warranty duration as the units they are designed to fit.
- All hand tools are covered by a limited lifetime warranty. Warranty is handled through ECHO's Consumer Support Department. For specific information, visit www.echo-usa.com. The wooden handle is a natural product that cannot be warranted. A handle that breaks due to misuse, mis-strike, abuse, or neglect is not covered by warranty. If you feel the handle broke prematurely due to a defect, please contact ECHO consumer support.
- All handheld sprayers of 50 ounces or less are covered by a 90-day warranty for homeowner applications.
- All generators, spreaders, power washers, and battery powered products are covered by separate limited warranties. Visit www.echo-usa.com for specific information.

COMMERCIAL APPLICATION

- **1 YEAR WARRANTY** - All Chain Saws and Cut-Off Saws and Cut-off Saw Carts for commercial, institutional, agricultural, industrial, or income producing use will be covered by this limited warranty for one (1) year from the date of purchase.
- **2 YEAR WARRANTY** - All other units for commercial, institutional, agricultural, industrial, or income producing use will be covered by this limited warranty for two (2) years from the date of purchase.

EXCEPTIONS:

- For two-stroke engine powered products, the electronic ignition module, flexible drive cables, trimmer solid drive shafts and TC tines, are warranted for the **life*** of the product on parts only.
- Cutting attachments such as, but not limited to, bars, chains, sprockets, blades, tines, belts, PowerBroom[™] and nylon trimmer heads for commercial, institutional, agricultural, industrial, rental, or income producing will be covered for failures due to defects in material or workmanship for a period of **30 days** from original product purchase date. Any misuse from contact with concrete, rocks, or other structures is not covered by this warranty.

- Rapid Loader String Head carries a lifetime warranty on the line locking system, parts only; no labor. Refer to your operator's manual for string head installation and maintenance instructions.
- All SB-Series, Multipurpose Tool attachments, and PRO ATTACHMENT SERIES Split Shaft attachments carry the same warranty duration as the units they are designed to fit.
- All hand tools are covered by a limited lifetime warranty. Warranty is handled through ECHO's Consumer Support Department. For specific information, visit www.echo-usa.com. The wooden handle is a natural product that cannot be warranted. A handle that breaks due to misuse, mis-strike, abuse, or neglect is not covered by warranty. If you feel the handle broke prematurely due to a defect, please contact ECHO consumer support.
- All handheld sprayers of 50 ounces or less are not covered by warranty for commercial applications.
- All generators, spreaders, power washers, and battery powered products are covered by separate limited warranties. Visit www.echo-usa.com for specific information.

RENTAL APPLICATION

- **90 DAYS WARRANTY** - Units for rental use will be covered against defects in material and workmanship for a period of 90 days from the date of purchase.

EXCEPTIONS:

- All hand tools are covered by a limited lifetime warranty. Warranty is handled through ECHO's Consumer Support Department. For specific information, visit www.echo-usa.com. The wooden handle is a natural product that cannot be warranted. A handle that breaks due to misuse, mis-strike, abuse, or neglect is not covered by warranty. If you feel the handle broke prematurely due to a defect, please contact ECHO consumer support.
- All handheld sprayers, of 50 ounces or less are not covered by warranty for rental applications.
- All generators, spreaders, power washers, and battery powered products are covered by separate limited warranties. Visit www.echo-usa.com for specific information.

- * ECHO Incorporated's liability under the "Lifetime" coverage is limited to furnishing parts specified under the PRODUCT WARRANTY PERIOD section of this warranty statement for "Life" free of charge for a period of ten (10) years after the date of the complete unit's final production.

ECHO Incorporated does not offer an over the counter exchange program. Any product re-built or sold through an unauthorized dealer, or an unauthorized outlet store, is sold without ECHO Incorporated's limited warranty coverage. This Limited Warranty coverage is extended to the original purchaser only, and is not transferable except for emission related parts. Repair parts and accessories replaced under this warranty are warranted only for the balance of the original unit or accessory warranty period. Any damage caused by improper installation or improper maintenance is not covered by this warranty. All parts or products replaced under warranty become the property of ECHO Incorporated.

PURCHASED REPAIR PARTS, SHORT BLOCKS AND ACCESSORIES

- 90-day homeowner, or non-income producing warranty
- 30-day commercial, institutional, agricultural, industrial, income producing, or rental application warrant

ATTENTION TWO-STROKE ENGINE POWER PRODUCT OWNERS

Two-stroke engine power products are quality-engineered and manufactured to exact tolerances to provide superior performance. To help ensure the performance of the unit, it is required to use two-stroke oil which meets the ISO-L-EGD Standard per ISO/CD 13738 and JASO M345FD Standards. ECHO and Shindaiwa branded oils are premium two-stroke oils specifically formulated to meet ISO-L-EGD (ISO/CD 13738) and JASO M345FD Standards. The use of two-stroke oils designed for other applications, such as for outboard motors or lawnmowers can result in severe engine damage, and will void your two-stroke engine limited warranty.

THIS WARRANTY DOES NOT COVER DAMAGE CAUSED BY:

- Lack of lubrication or engine failure, due to the use of two-stroke oils that do not meet the ISO-L-EGD (ISO/CD 13738) and JASO M345FD Standards. Engine problems due to inadequate lubrication caused by failure to use an ISO-L-EGD compliant and JASO M345FD registered oil, will void the two-stroke engine limited warranty. ECHO and Shindaiwa branded oils meet the ISO-L-EGD and JASO M345FD Standard. Emission related parts are covered for 5 years homeowner use or 2 years commercial use regardless of two-stroke oil used, per the statement listed in the EPA or California Emission Defect Warranty Explanation.
- Damage caused by use of gasohol, containing methanol (wood alcohol), or gasoline containing less than 89 octane. Only use gasoline which contains 89 octane or higher. Gasohol which contains a **maximum** 10% ethanol (grain alcohol) or 15% MTBE (methyl/tertiary/butyl/ether) is also approved. The prescribed mixing ratio of gasoline to oil is listed on the oil label and covered in your operator's manual.
- Engine damage caused by use of ether or any starting fluids.
- Damage caused by tampering with engine speed governor or emission components, or running engines above specified and recommended engine speeds as listed in your operator's manual.
- Operation of the unit with improperly maintained/removed cutting shield or removed/damaged air filter.
- Damage caused by dirt, pressure or steam cleaning the unit, salt water, corrosion, rust, varnish, abrasives, and moisture.
- Defects, malfunctions or failures resulting from abuse, misuse, neglect, modifications, alterations, normal wear, improper servicing, or use of unauthorized attachments.
- Incorrect storage procedures, stale fuel, including failure to provide or perform required maintenance services as prescribed in the operator's manual. Preventative maintenance as outlined in the operator's manual is the customer's responsibility.
- Failures due to improper set-up, pre-delivery service or repair service by anyone other than authorized servicing dealer during the warranty period.
- Certain parts and other items are not warranted, including but not limited to: lubricants, starter cords, and engine tune-ups.
- Use of spark plugs other than those meeting performance and durability requirements of the OEM spark plug listed in the Operator's Manuals.

- Overheating or carbon scoring failures due to restricted, clogged exhaust port or combustion chamber, including damage to spark arrester screen.
- Adjustments after the first (30) thirty days and beyond, such as carburetor adjustment and throttle cable adjustment.
- Damage to gears or gear cases caused by contaminated grease or oil, use of incorrect type or viscosity of lubricants, and/or failure to comply with recommended grease or oil change intervals.
- Damage caused by loading SHRED 'N' VAC® beyond recommended capacity.
- Damage caused by pump or sprayer running dry, pumping or spraying caustic or flammable materials, or lack of or broken strainers.
- Additional damage to parts or components due to continued use after operational problem or failure occurs. Should operational problem or failure occur, the product should not be used, but delivered as is to an authorized servicing dealer.

It is a dealer's and/or customer's responsibility to complete and return the warranty registration card supplied with your product or by visiting www.echo-usa.com or www.shindaiwa-usa.com. Your receipt of purchase including date, model and serial number must be maintained and presented to an authorized servicing dealer for warranty service. Proof of purchase rests solely with the customer. Some states do not allow limitations on how long an implied warranty lasts, so the above limitations may not apply to you. Some states do not allow the exclusion or limitation of incidental or consequential damages, so you may also have other specific legal rights which vary from state to state. This limited warranty is given by ECHO Incorporated, 400 Oakwood Rd., Lake Zurich, IL 60047.

DISCLAIMER OF IMPLIED WARRANTIES

This limited warranty is in lieu of all other expressed or implied warranties, including any warranty of FITNESS FOR A PARTICULAR PURPOSE OR USE and any implied warranty of **MERCHANTABILITY** otherwise applicable to this product. ECHO Incorporated and its affiliated companies shall not be liable for any special incidental or consequential damage, including lost profits. There are no warranties extended other than as provided herein, except for the emission control warranty statement that is provided separately with the product when originally purchased. This limited warranty may be modified only by ECHO Incorporated.

507MS0000001 - 507MS9999999

shindaiwa[®]

ECHO INCORPORATED

400 Oakwood Road

Lake Zurich, IL 60047

www.echo-usa.com